

HOTEL SUPPLIES

YirouFang Textile Manufacture Co.,Ltd.



Visit Factory

360° VR panoramas we provide



2018-8-15

<http://www.yrftextile.com>

Email: info@yrftextile.com

YRF
HOTEL SUPPLY



YRF
HOTEL SUPPLY



YRF
HOTEL SUPPLY





Begin with appearance
End with quality

Consistent color on the front, more artistic
Excellent quality, high standard material selection
Exquisite craftsmanship, custom made for you





Better electric system

- Cutting-edge noise-free technology, quieter is better.
- Embedded wireless control system
- Reversing, inching, linkage and other functions
- Perfect performance, compact structure
- Accurate positioning, embedded brake system





8735

09



8739

10



8737

11



8731

13



8101

14



8501

15

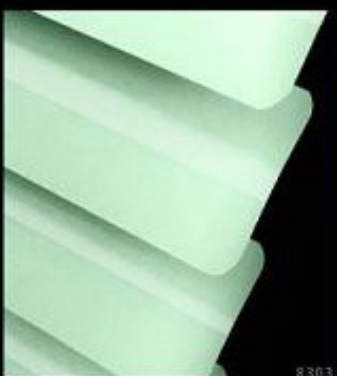

8303

16



8305

17



8401

18



8602

19

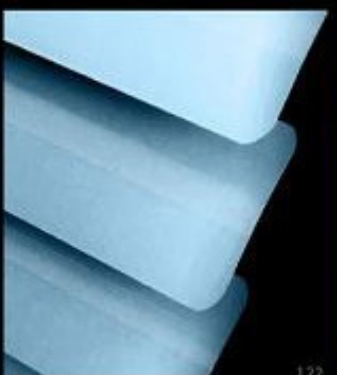

122

20



8207

21



**Aluminum-magnesium
alloyed venetian blinds**



Multiple mounting modes

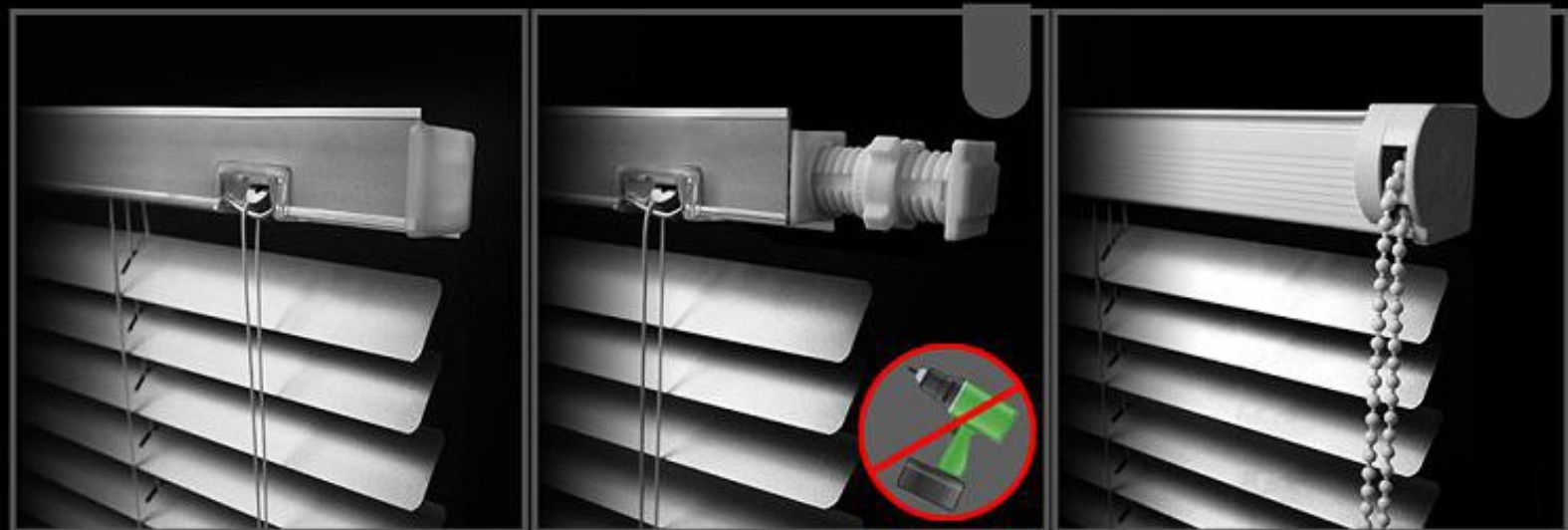

Classic type

Classic rod and rope drawing system, smooth and convenient to operate

Drilling-free type

No need for tools, easy to install

Draw beads type

Just a piece of beads rope to control the lifting and rotating of curtain, very easy



Office

Product parameters



Product name	Frosted series	Twinkling series	Solid-color series
Curtain type	Venetian blinds	Venetian blinds	Venetian blinds
Material of blinds	Al-mg alloy	Al-mg alloy	Al-mg alloy
Size of blinds	2.5cmx0.16mmX customized width		
Size of track	2.85cmX3.15cmX customized width		
Weight per square	Net weight≈1.3Kg		
Color fastness	≥ 5	≥ 5	≥ 5
Mounting mode	Interior mounting/ exterior mounting		
Width limit	200cm> Clear width >40cm		
Height limit	500cm> Clear height >40cm		
Depth of window frame	>4.5cm		



717

01

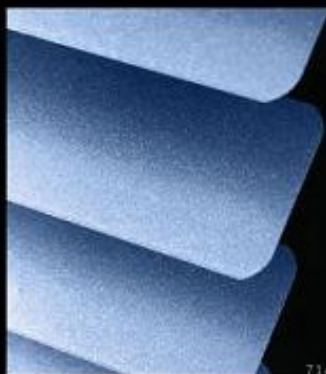

714

02



716

03

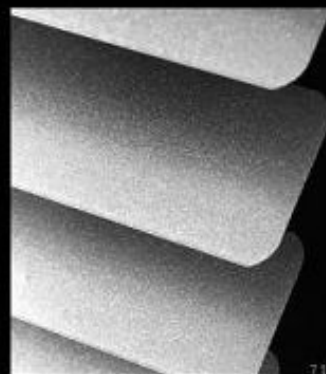

713

04



8732

05

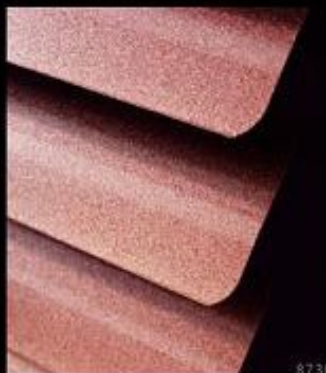

8730

06



8738

07



8736

08

Installation Notes for classic type

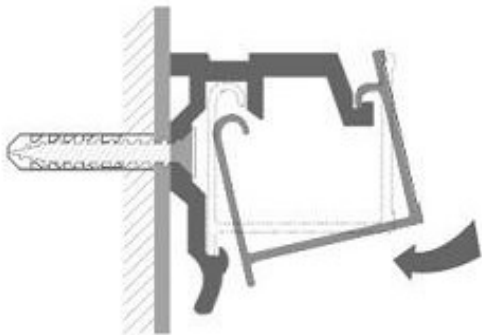

▲ Side mounting

Fix the holder with screw on the side wall.
Put the top track onto the holder and push it inward until it is fastened.

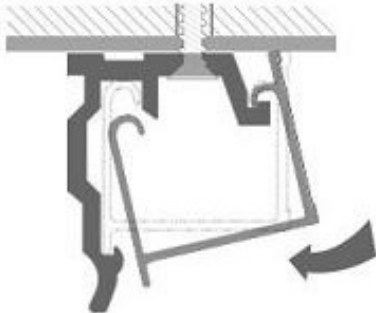

▲ Top mounting

Fix the holder with screw on the ceiling.
Put the top track onto the holder and push it inward until it is fastened.

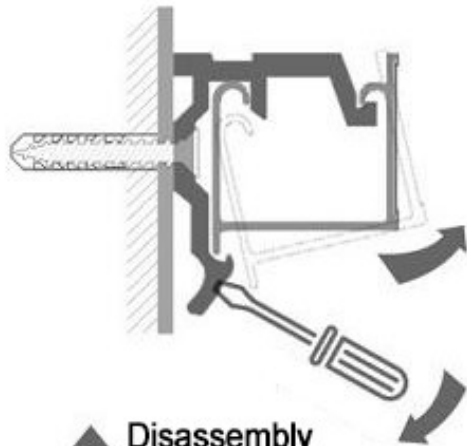

▲ Disassembly

Insert a straight screwdriver into the small hole as shown in the picture below, gently press down and then remove the curtain.

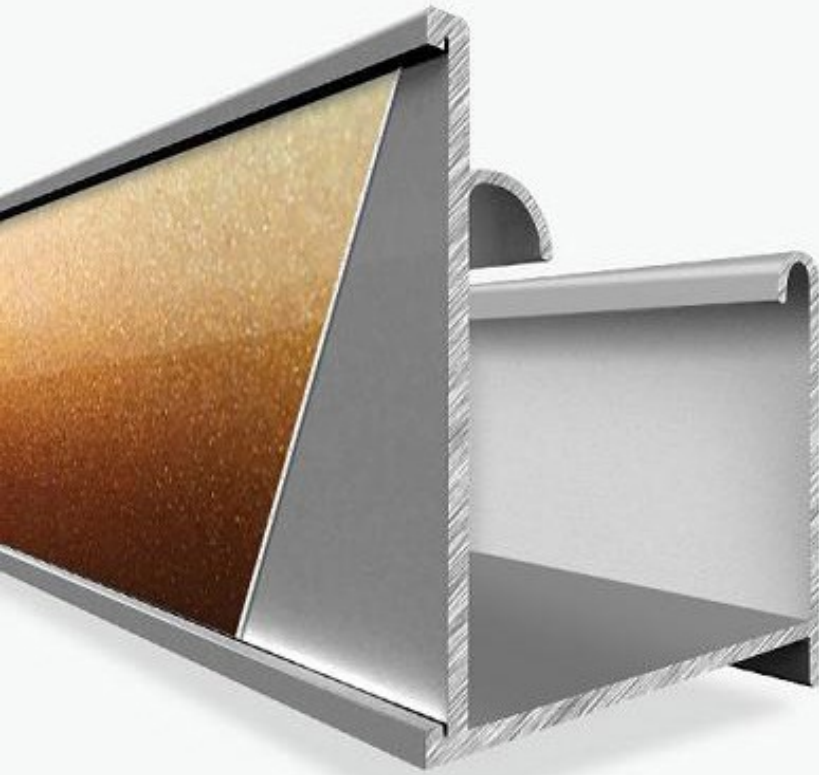

Quality aluminum track

Electrophoretic highlighting process for surface

Waterproof and rustproof

High bearing capacity

Color-matched baffle plate

Quality blinds

High strength, high resilience, aluminum alloy material

Double coating for better durability

Thickened blinds for better shading effect.

High color fastness, never fade under long-term exposure to the sun

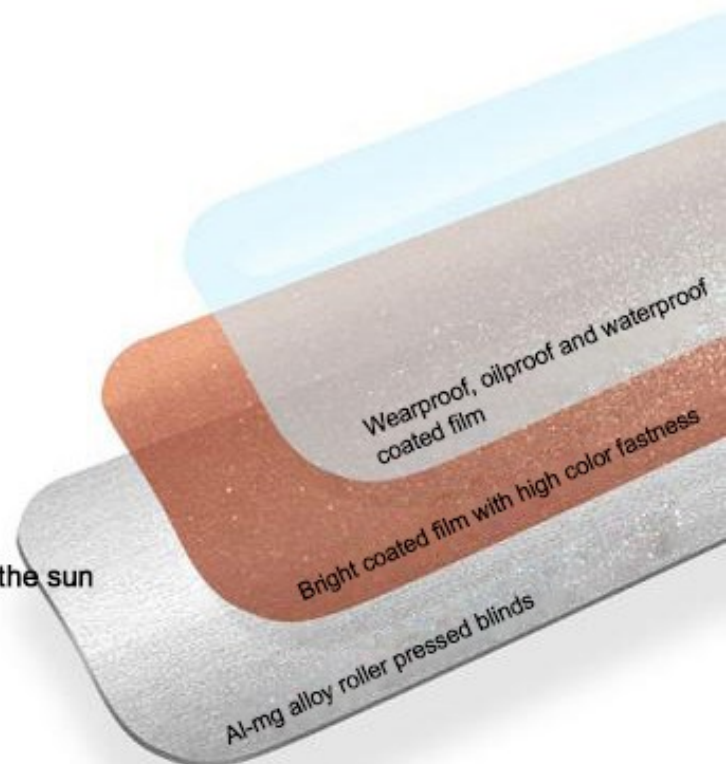



**Waterproof, oilproof
and easy to clean**

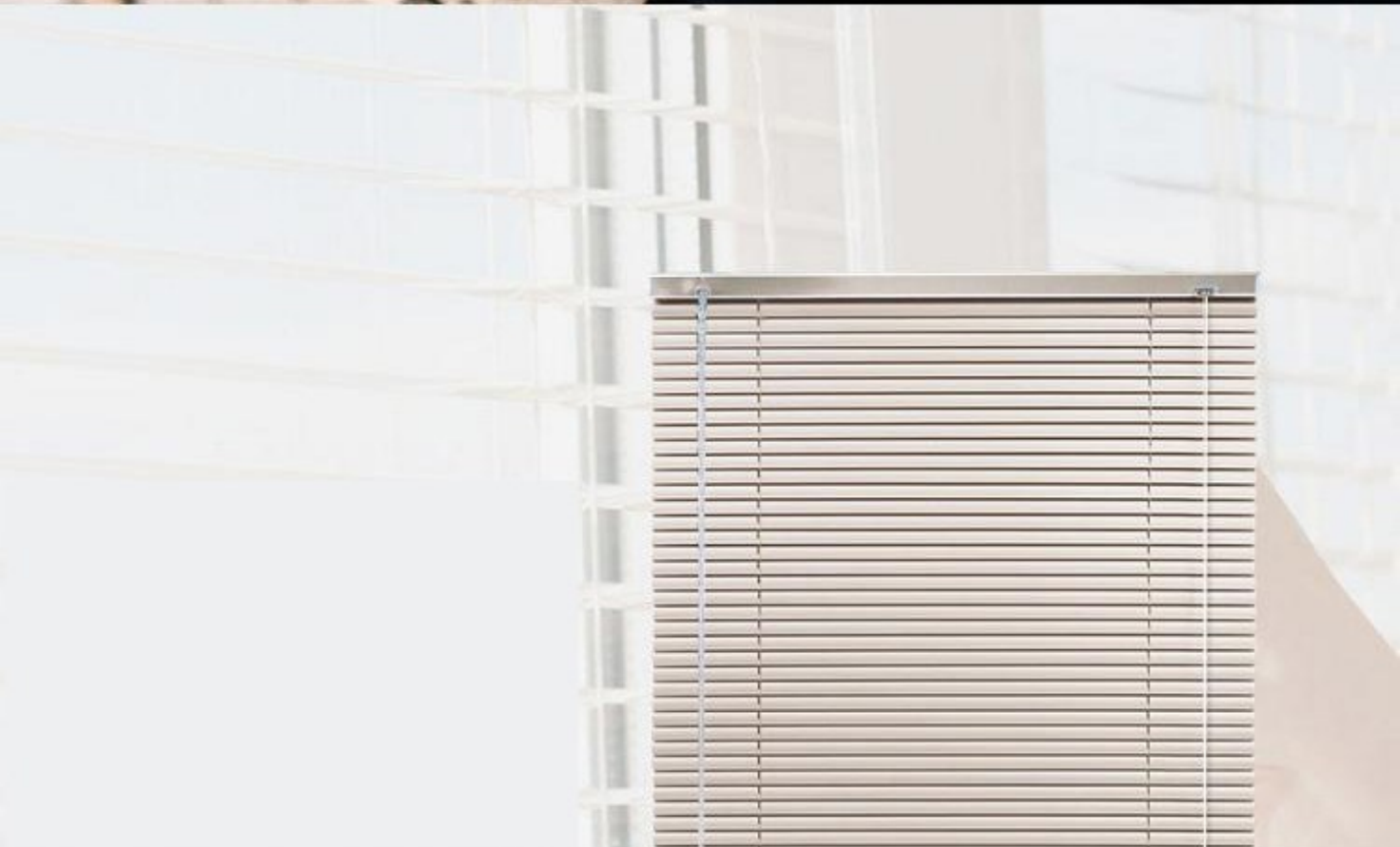



PURSUIT OF EXCELLENCE



Double coated, twinkling and shiny



Color-matched aluminium alloy top track, quality material



Crystal acrylic handle



Durable nylon ladder rope



High-quality acrylic ladder rope plug



Weighted and color-matched aluminium alloy bottom track

Classic control mode for venetian blinds



Opening or closing the blinds

Rotate the handle so that the blinds can rotate as well.

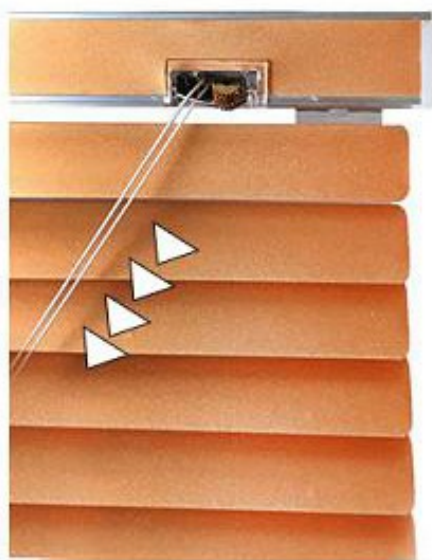

Lift or lower the blinds

Stretch the cord to the left to lower the curtain.

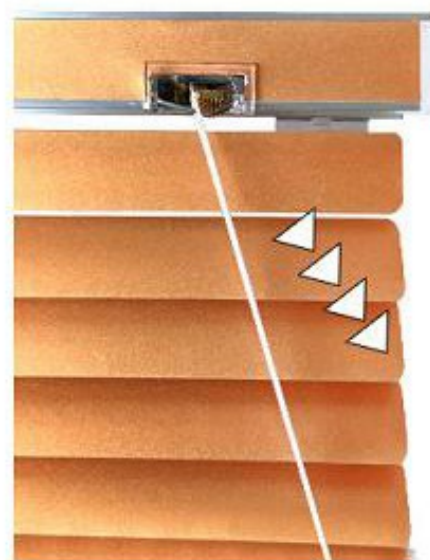

Lock the curtain in place

Stretch the cord to the right to lock the curtain in place

Upgraded electric type, more convenient, start an era of smart home



Better electric system

- Cutting-edge noise-free technology, quieter is better.
- Embedded wireless control system
- Reversing, inching, linkage and other functions
- Perfect performance, compact structure
- Accurate positioning, embedded brake system



Delicate and concise

Powerful electric system makes control more convenient than ever.

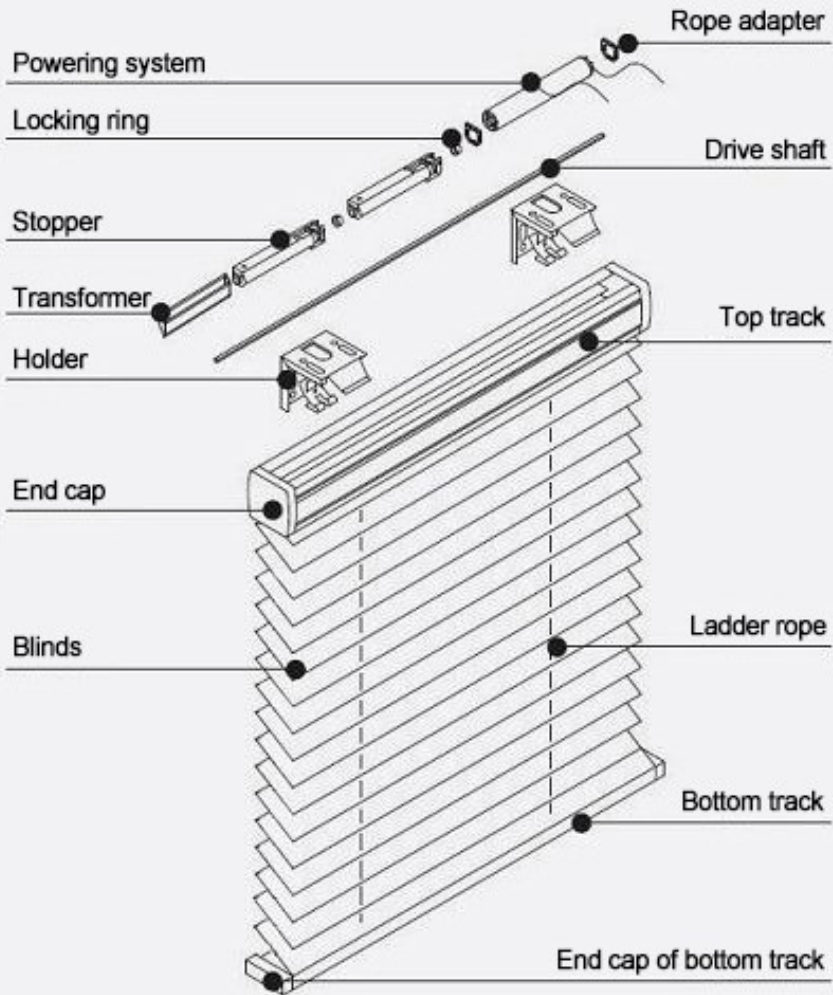

Preferred accessories, easy to install and really durable

Upon receipt of the product, please check carefully whether the accessories in the package are complete. Just install when all accessories are ready.



Installation steps

Steps to install the curtain in the window frame



1 Measure and mark the installation location



2 Fix the holder in the marked position



3 Snap the top track into the holder



4 Completed

Steps to install the curtain out of the window frame



1 Measure and mark the installation location



2 Fix the holder in the marked position



3 Snap the top track into the holder



4 Completed